INSTRUCTION BOOK

**RF DIRECTIONAL
THRULINE® WATTMETER
MODEL 43**

Also Covers Models 4431, 43P
And Series 4300, 4520

BIRD®

Electronic Corporation
Cleveland (Solon) Ohio USA

©*Copyright* 2004 by Bird Electronic Corporation
Instruction Book Part Number 920-43 Rev. E

Thruline® and Termaline® are registered trademarks
of Bird Electronic Corporation

Safety Precautions

The following are general safety precautions that are not necessarily related to any specific part or procedure, and do not necessarily appear elsewhere in this publication. These precautions must be thoroughly understood and applied to all phases of operation and maintenance.

Keep Away From Live Circuits

Operating personnel must at all times observe general safety precautions. Do not replace components or make adjustments to the inside of the test equipment with the high voltage supply turned on. To avoid casualties, always remove power.

Shock Hazard

Do not attempt to remove the RF transmission line while RF power is present. Radiated RF power is a potential health hazard.

Do Not Service or Adjust Alone

Under no circumstances should any person reach into an enclosure to service or adjust the equipment except in the presence of someone who is capable of rendering aid.

Safety Earth Ground

An uninterruptible safety earth ground must be supplied from the main power source to test instruments. Grounding one conductor of a two conductor power cable is not sufficient protection. Serious injury or death can occur if this grounding is not properly installed.

Resuscitation

Personnel working with or near high voltages should be familiar with modern methods of resuscitation.

Safety Symbols

WARNING

Warning notes call attention to a procedure, which if not correctly performed, could result in personal injury.

CAUTION

Caution notes call attention to a procedure, which if not correctly performed, could result in damage to the instrument.



This symbol appears on the equipment indicating there is important information in the instruction manual regarding that particular area.

 **NOTE:** Calls attention to supplemental information

Warning Statements

The following warnings appear in the text where there is danger to operating and maintenance personnel, and are repeated here for emphasis.

WARNING

Leaking RF energy is a potential health hazard. Never attempt to connect or disconnect equipment from the transmission line while RF power is being applied. Severe burns, electrical shock, or death can occur.

WARNING

When working with RF powers of 200 watts or more, the potential of the center conductor of the line section will be over 100 volts. Do not touch the center conductor while RF power is on.

Caution Statements

The following equipment cautions appear in the text whenever the equipment is in danger of damage, and are repeated here for emphasis.

CAUTION

For low reflection measurements, do not rotate the reflected power element to read forward power. Damage to the element or wattmeter could result.

CAUTION

Handle elements with care. Calibration could be disturbed if they are dropped.

CAUTION

Do not attempt to remove the RF center conductor. This will damage the line section.

Safety Statements



USAGE

ANY USE OF THIS INSTRUMENT IN A MANNER NOT SPECIFIED BY THE MANUFACTURER MAY IMPAIR THE INSTRUMENT'S SAFETY PROTECTION.

USO

EL USO DE ESTE INSTRUMENTO DE MANERA NO ESPECIFICADA POR EL FABRICANTE, PUEDE ANULAR LA PROTECCIÓN DE SEGURIDAD DEL INSTRUMENTO.

BENUTZUNG

WIRD DAS GERÄT AUF ANDERE WEISE VERWENDET ALS VOM HERSTELLER BESCHRIEBEN, KANN DIE GERÄTESICHERHEIT BEEINTRÄCHTIGT WERDEN.

UTILISATION

TOUTE UTILISATION DE CET INSTRUMENT QUI N'EST PAS EXPLICITEMENT PRÉVUE PAR LE FABRICANT PEUT ENDOMMAGER LE DISPOSITIF DE PROTECTION DE L'INSTRUMENT.

IMPIEGO

QUALORA QUESTO STRUMENTO VENISSE UTILIZZATO IN MODO DIVERSO DA COME SPECIFICATO DAL PRODUTTORE LA PROZIONE DI SICUREZZA POTREBBE VENIRNE COMPROMESSA.



SERVICE

SERVICING INSTRUCTIONS ARE FOR USE BY SERVICE - TRAINED PERSONNEL ONLY. TO AVOID DANGEROUS ELECTRIC SHOCK, DO NOT PERFORM ANY SERVICING UNLESS QUALIFIED TO DO SO.

SERVICIO

LAS INSTRUCCIONES DE SERVICIO SON PARA USO EXCLUSIVO DEL PERSONAL DE SERVICIO CAPACITADO. PARA EVITAR EL PELIGRO DE DESCARGAS ELÉCTRICAS, NO REALICE NINGÚN SERVICIO A MENOS QUE ESTÉ CAPACITADO PARA HACERLO.

WARTUNG

ANWEISUNGEN FÜR DIE WARTUNG DES GERÄTES GELTEN NUR FÜR GESCHULTES FACHPERSONAL.

ZUR VERMEIDUNG GEFÄHRLICHE, ELEKTRISCHE SCHOCKS, SIND WARTUNGSARBEITEN AUSSCHLIEßLICH VON QUALIFIZIERTEM SERVICEPERSONAL DURCHZUFÜHREN.

ENTRENTIEN

L'EMPLOI DES INSTRUCTIONS D'ENTRETIEN DOIT ÊTRE RÉSERVÉ AU PERSONNEL FORMÉ AUX OPÉRATIONS D'ENTRETIEN. POUR PRÉVENIR UN CHOC ÉLECTRIQUE DANGEREUX, NE PAS EFFECTUER D'ENTRETIEN SI L'ON N'A PAS ÉTÉ QUALIFIÉ POUR CE FAIRE.



RF VOLTAGE MAY BE PRESENT IN RF ELEMENT SOCKET - KEEP ELEMENT IN SOCKET DURING OPERATION.

DE LA TENSION H.F. PEAT ÊTRE PRÉSENTE DANS LA PRISE DE L'ÉLÉMENT H.F. - CONSERVER L'ÉLÉMENT DANS LA PRISE LORS DE L'EMPLOI.

HF-SPANNUNG KANN IN DER HF-ELEMENT-BUCHSE ANSTEHEN - ELEMENT WÄHREND DES BETRIEBS EINGESTÖPSELT LASSEN.

PUEDE HABER VOLTAJE RF EN EL ENCHUFE DEL ELEMENTO RF - MANTENGA EL ELEMENTO EN EL ENCHUFE DURANTE LA OPERACION.

IL PORTAELEMENTO RF PUÒ PRESENTARE VOLTAGGIO RF - TENERE L'ELEMENTO NELLA PRESA DURANTE IL FUNZIONAMENTO.

About This Manual

This instruction book covers RF Directional Thruline Wattmeters Models:

43	43P	4305A	4431		
4521	4522	4523	4525	4526	4527

This instruction book is arranged so that essential safety information appears in the front of the book. Reading the Safety Precautions Section before operating the equipment is strongly advised.

The remainder of this Instruction Book is divided into Chapters and Sections. At the beginning of each chapter, a general overview describes the contents of that chapter.

Operation

First time users should read Chapter 1 - Introduction, Chapter 3 - Installation, and Chapter 2 - Theory of Operation, to get an overview of equipment capabilities and installation. Specifications are provided in Chapter 7 - Specifications. An experienced operator can refer to Chapter 4 - Operating Instructions. All instructions necessary to operate the equipment appears in this chapter. If you are not using the Model 43, refer to Chapter 6 - Model Differences for instructions specific to your unit.

Maintenance

All personnel should be familiar with the preventive maintenance found in Chapter 5 - Maintenance. If a failure should occur, the troubleshooting section will aid in isolating and correcting the cause.

Changes to This Manual

We have made every effort to ensure this manual is accurate. If you should discover any errors or if you have suggestions for improving this manual, please send your comment to our factory. This manual may be periodically updated. When inquiring about updates to this manual refer to the part number and revision level on the title page.

Table of Contents

Safety Precautions	i
About This Manual	vi
Introduction	1
Purpose and Function	1
Performance Characteristics and Capabilities	1
Theory of Operation	5
Travelling Wave Viewpoint	5
Coupling Circuit	6
Load Power	7
Standing Wave vs. Travelling Wave Viewpoint	8
ρ vs. ϕ	8
Low Reflection Measurements	12
Transmitter Monitoring	13
Component Testing	13
Frequency Response	14
Impedance Mismatch	16
Installation	17
Connections	17
Remote Installation	18
Operating Instructions	21
Normal Operation	21
Load Matching	25
Maintenance	27

Troubleshooting	27
Cleaning	28
Contact Adjustment	29
Zero Adjust.	30
Storage	30
Customer Service	31
Bird 43 Replacement Parts List	32
Available "QC" Type Connectors	33

Model Differences 35

Bird 43P Peak Wattmeter	35
Operation.	35
Peak Detector Response.	35
Rectangular Pulses	36
Peak Calibration	36
Maintenance	37
Bird 4305A Thruline Wattmeter	38
Bird 4305A Replacement Parts List.	38
Bird 4431 Thruline Wattmeter	39
Maintenance	40
Bird 4431 Replacement Parts List.	41
Bird 4520 Series Thruline Wattmeters	42
Installation	42
Operation.	42
Bird 4520 Series Replacement Parts List	42

Specifications 45

Purpose and Function

This manual covers the operation of the Bird 43 Thruline Wattmeter and its descendants. Two models have RF sampler ports, while the Bird 43P can measure peak power. The Bird 4520 series come ready for panel mounting. Differences are discussed in Chapter 6, on page 35. Except where indicated, instructions and specifications for the 43 apply to other models also.

The 43 is an insertion-type RF wattmeter, designed to measure RF power and load match in 50 ohm coaxial transmission lines. It is intended for use with CW, AM, FM, and TV modulation, but not pulse modulation. When used in 50 ohm applications, the 43 has a maximum VSWR of 1.05 for frequencies up to 1000 MHz. The meter provides direct readings in watts with an expanded scale for easy reading. The scale is graduated for 25, 50, and 100 full scale. Elements are available in a variety of power and frequency ranges (see the Bird Electronic Corporation Catalog for details).

Performance Characteristics and Capabilities

The Bird 43 is portable, with an attached carrying strap. It has an aluminum housing and an easily removed back cover, with bumpers on the base and back that allow the meter to stand or lie flat. For additional protection, the microammeter is specially shock mounted. A slotted screw on the lower front face of the meter is used to zero the pointer. Below the meter face, the RF line section protrudes slightly from the wattmeter housing with the element socket in the center.

A shielded cable connects the RF line section to the rest of the wattmeter. This lets you remove the line section from the wattmeter housing for custom installation and still make measurements. The RF line section is precision machined to provide the best possible impedance match to the transmission line under test. A formed phosphor-bronze spring finger protrudes into the element socket to make contact with the element.

At each end of the line section are Bird Quick-Change RF connectors that may be interchanged with any other Bird "QC" connector. The wattmeter housing does not interfere with connector changes.

To make measurements, a Bird Plug-In Element is inserted into the line section socket and rotated against one of the stops. A small catch in the corner of the socket face presses on the shoulder of the element to keep it in proper alignment. This assures good contact between the spring finger and the element contact and between the lower edge of the element and the line section body (see Figure 1).

*Figure 1
Securing an
element*

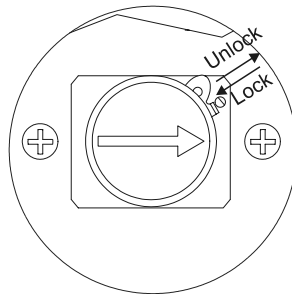

Contacts on opposite sides of the element connect with the spring finger when the element is in the forward or reverse position. This occurs when the stop pin on the element is against either stop and the catch is in place.

Figure 2
Bird 43 Thru-line Wattmeter
Outline Drawing

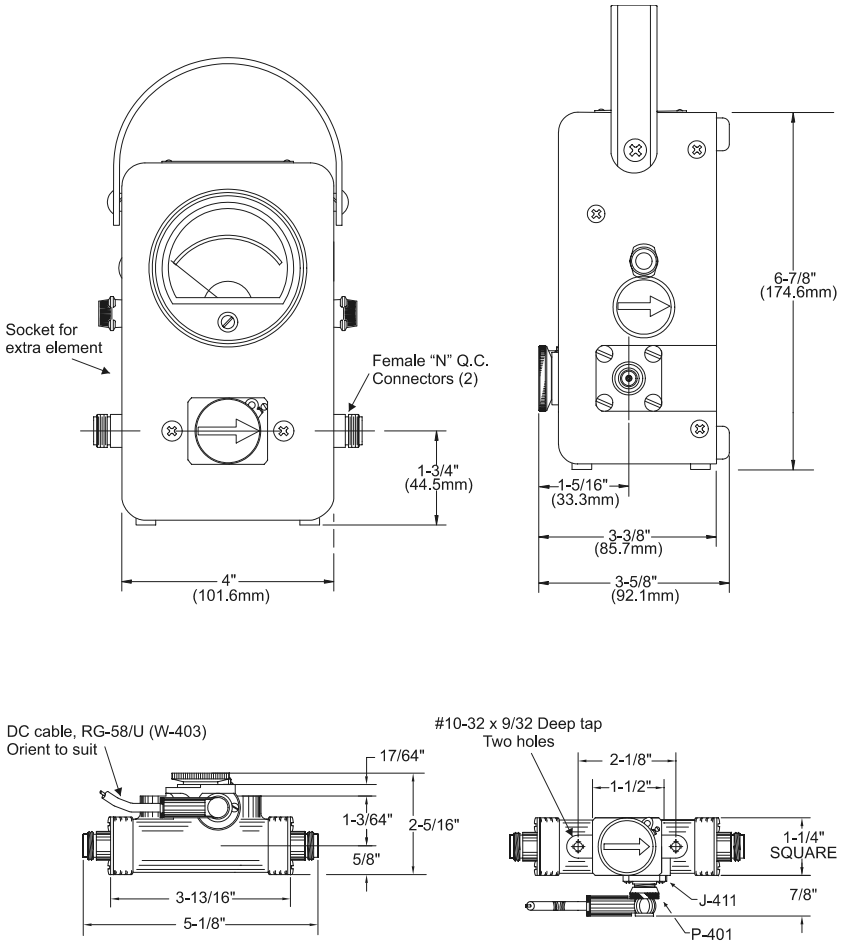

Travelling Wave Viewpoint

The easiest way to visualize Thru-line operation is from a travelling wave viewpoint. In transmission lines the voltages, currents, standing waves, etc., on any uniform line section result from the interaction of two travelling waves:

- The forward wave (and its power) travels from the source to the load. It has RF voltage E_f and current I_f in phase, with $E_f / I_f = Z_0$.
- The reflected wave (and its power) originates by reflection at the load and travels from the load back to the source. It has an RF voltage E_r and current I_r in phase, with $E_r / I_r = Z_0$.

Each wave is mathematically simple and has a constant power:

$$W_f = \text{Watts Forward} = E_f^2 / Z_0 = I_f^2 Z_0 = E_f I_f$$

$$W_r = \text{Watts Reflected} = E_r^2 / Z_0 = I_r^2 Z_0 = E_r I_r$$

Z_0 is the characteristic impedance of a uniform line section. For useful lines it is usually a pure resistance of 50 ohms. The RF circuit of the Bird 43 is a length of uniform air line with $Z_0 = 50$ ohms.

Coupling Circuit

The coupling circuit that samples the travelling waves is in the Bird Plug-In Element. The element circuitry and its relationship to the rest of the Bird 43 are illustrated in Figure 3.

Figure 3
Thru-Line Wattmeter Schematic

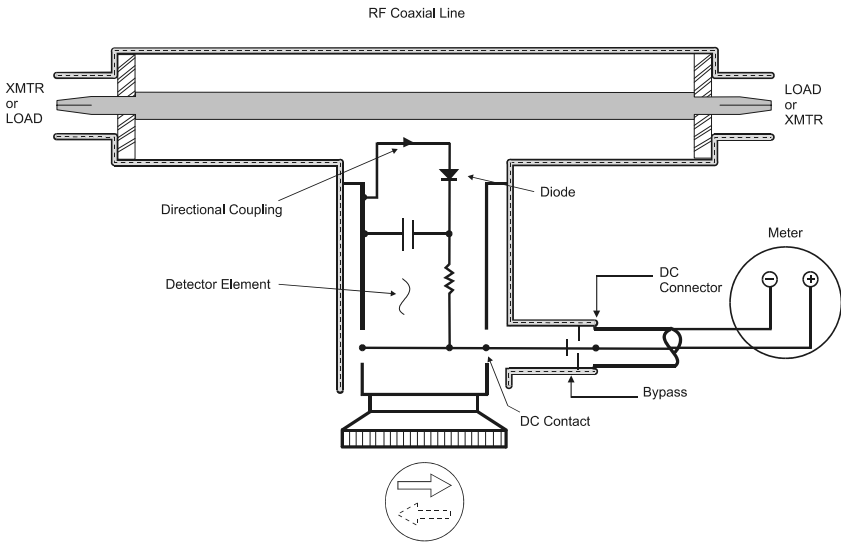

Current is produced in the coupling circuit by the travelling waves in the line section. Both inductive and capacitive coupling contribute to this. The inductive current flows in the direction of the travelling wave. The capacitive current is independent of the direction of the travelling wave. Therefore, the inductive current produced by one of the travelling waves will add in phase with the corresponding

capacitive current, while that produced by the wave travelling in the opposite direction will subtract. The additive or “arrow” direction is assigned to the forward wave.

The electrical characteristics of the element are carefully adjusted so that, for the reverse travelling wave, the inductive current will completely cancel the capacitive current. The result is directivity greater than 25 dB. Thus, the element is sensitive at either of its settings, but to only one of the two travelling waves. Thru-line Wattmeter measurements are also independent of position along the transmission line.

Like similar diode devices, the Bird 43 indicates the carrier component of amplitude modulation, with very little response to side band components added by modulation.

Load Power

For loads with a VSWR of 1.2 or less, the power dissipated in a load (W_l) is equivalent (with less than one percent error) to the forward power (W_f). When appreciable power is reflected, as with an antenna, it is necessary to use the exact load power which is given by:

$$W_l = \text{Watts into Load} = W_f - W_r$$

Good load resistors, such as Bird Termline loads, will give negligible reflected power.

Standing Wave vs. Travelling Wave Viewpoint

As mentioned previously, the Thruline Wattmeter reacts to forward and reverse travelling waves to measure power in a transmission line. The standing wave viewpoint, also widely used, is highly developed both in theory and in practice. This viewpoint can be traced to the early use of slotted transmission lines.

The slotted line measures the standing wave ratio by mechanically positioning a voltage detector at peaks and nulls along a length of line section. Its drawbacks are that it is usually too long, too expensive for good accuracy, not portable, and too slow. These problems grow rapidly as the measurement frequency drops below 1000 MHz. The Thruline Wattmeter by comparison is fast, convenient, and accurate. It provides the same information as a slotted line with the exception of the phase angle of the reflection coefficient (distance, load to minimum).

ρ vs. ϕ

The simple relationships:

$$\rho = \frac{1 + \sqrt{\phi}}{1 - \sqrt{\phi}} \text{ and } \phi = \left[\frac{\rho - 1}{\rho + 1} \right]^2 \quad \text{Where } \rho = \text{VSWR}$$

and $\phi = W_r / W_f$

can be used to convert between the standing wave ratio (ρ) and the reflected/forward power ratio (ϕ), which can be directly read from the Thruline Wattmeter. The relationship between ρ and ϕ is graphed in Figure 4 and Figure 5.

☞ NOTE: Attenuation, measured in dB, can be derived from the power ratio by the equation $N_{\text{db}} = 10 \log \phi$.

VSWR scales and their attendant controls for setting the reference point have been intentionally omitted from the Bird 43. Experience using the ThruLine Wattmeter for transmitter tune-up, antenna matching, etc. will show that the power ratio measurement is as useful in practice as the standing wave ratio.

A trial is suggested – forget about VSWR for a few days and think in terms of $\phi = W_r / W_f$. The two meter readings, W_r and W_f , give a useful, approximate picture of the results without bothering to calculate the power ratio exactly. Consider that, for an antenna matching problem, the main objective usually is to minimize W_r . Anything done experimentally to this end will be seen when the element is turned to the reflected power position.

Figure 4
Percent Reflected Power vs. VSWR (1.0 – 1.3)

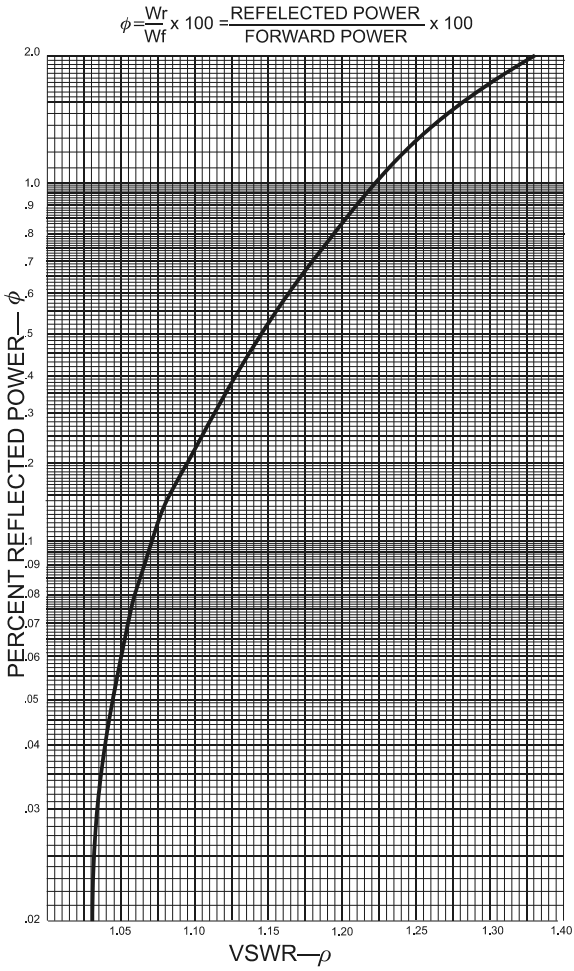
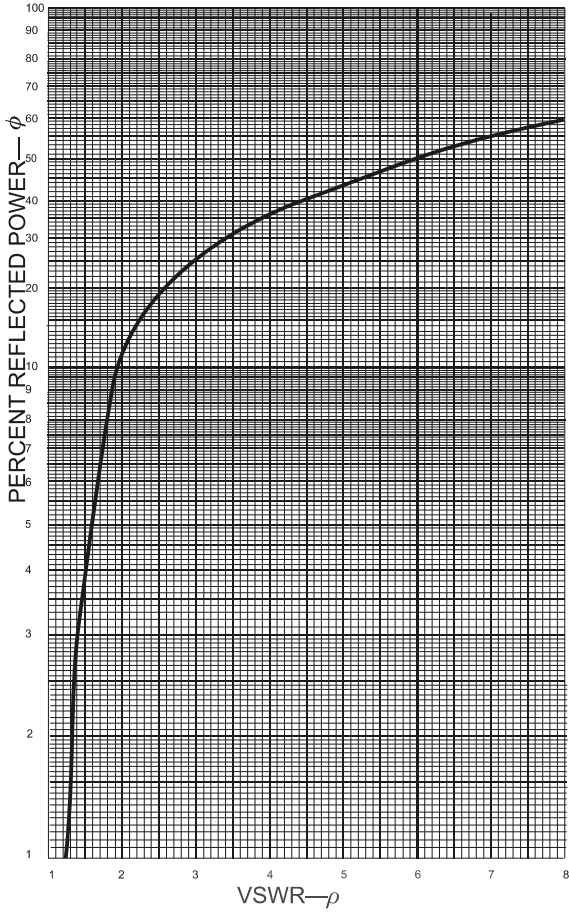

Figure 5
Percent Reflected Power vs. VSWR (1.0 – 8.0)

$$\phi = \frac{W_r}{W_f} \times 100 = \frac{\text{REFLECTED POWER}}{\text{FORWARD POWER}} \times 100$$



Low Reflection Measurements

$\phi = 10\%$ ($\rho = 2$) is the typical limit of antenna match. Further effort is frequently not worthwhile because below this level reflected power is hard to measure, and W_1 can not be significantly increased. TV and VHF transmitters are examples of systems requiring lower reflected power but for reasons other than maximizing power transmission.

CAUTION

For low reflection measurements, do not rotate the reflected power element to read forward power. Damage to the element or wattmeter could result

When the same element is used to measure both forward and reflected power, meaningful readings are possible down to about $\phi = 5\%$ ($\rho = 1.5$). For accurate measurement of very low levels of reflected power, i.e. $\phi = 0.6\%$ ($\rho = 1.17$), use a second element rated at one tenth of the full scale power of the forward element. This method should not be used with element ranges differing by more than 10:1.

For example, consider an 80 watt transmitter and a Bird 43 with 100 and 10 watt elements. Measure W_f with the 100 W element. Measure W_r using the 10 W element (with the arrow pointing towards the transmitter). W_r can be measured down to at least 0.5 W, so that $\phi = 0.5 / 80$ or about 0.6%, corresponding to $\rho = 1.17$.

Transmitter Monitoring

The Thruline Wattmeter can be used for the continuous monitoring of transmitter output or reflected power, for instance in checking intermittent antenna or line faults.

Component Testing

The Bird 43 is very helpful in component testing, and may be employed in several ways:

1. VSWR or ϕ may be measured by placing the component under test between the wattmeter and a good load resistor.
 2. Attenuation (power lost by heat in a line) as well as VSWR may be measured by inserting the unknown line between two Thruline wattmeters, or between a Thruline wattmeter and a Termaline absorption wattmeter.
-  **NOTE:** Very small attenuations require allowance for normal instrument errors. To correct for this without any calculations, simply connect the wattmeters directly, with no line between them, and adjust their zero settings until they are both zeroed.
3. Line loss using open circuit calibration: The high directivity of elements can be exploited in line loss measurements, because of the equality of forward and reflected power with the load connector open or short circuited. In this state the forward and reflected waves have equal power, so that $\phi = 100\%$ and $\rho = \infty$. Open circuit testing is preferred to short circuit, because a high quality open circuit is easier to create than a high quality short. To measure insertion loss, use a high quality open circuit to check forward and reverse power equality, then connect an open-circuited,

unknown line to the wattmeter. The measured ϕ is the attenuation for *two* passes along the line (down and back). The attenuation can then be compared with published data for line type and length (remember to halve N_{db} or double the line length to account for the measurement technique).

This measurement should be supplemented by either time domain reflectometry or dc continuity and leakage checks, since the attenuation measurement alone cannot account for faults such as open or short circuits partway down the line.

 NOTE: Very small attenuations require allowance for normal instrument errors. Make sure to note exact readings, or their difference, on the initial equality check, and correct for this.

Frequency Response

Bird Plug-In Elements have a flat frequency response over their specified operating range. A sample set of curves is shown in Figure 6. Notice that for the low power element, the rolloff outside its frequency band is more pronounced than for the high power elements. For example, at 40 MHz the 10C element will have a loss of 4 dB, giving a reading of about 40% of the true value. For the 100C, the loss will only be about 1 dB, for a reading at 80% of the true value, and the 500C should be within the normal 5% of full scale tolerance.

Figure 6
Representative Frequency Response

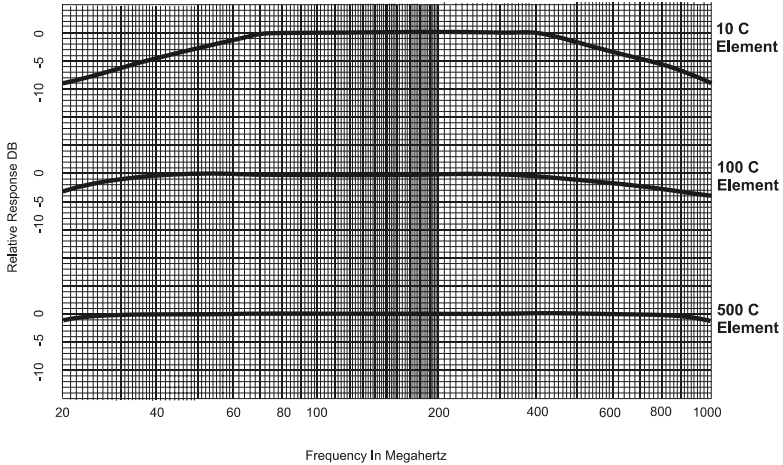

These curves are typical for all element types (H, A, B, C, D, ...) at their respective frequencies. Since a C type element has a frequency range of 100 - 250 MHz, response curves for other element types can be approximated by replacing the 100 and 250 MHz points on the chart with the extremes of the element's frequency range, and recalculating the other frequency points accordingly. For example, for a B element (range 50 - 125 MHz) simply divide all frequencies by two. For an E element (range 400 - 1000 MHz) multiply all frequencies by four.

Harmonics or subharmonics that lie outside of the frequency range of the element may exist in the circuit under test. A rough approximation of the element's response to harmonics can be made with these curves. Using an element for measurements outside of its frequency range is not recommended. The response curves presented are only typical, and not guaranteed.

Impedance Mismatch

There may be cases where it is necessary to use the Bird 43 with a non-50 ohm transmission line. If the reflected power is less than 10% and the frequency is below 200 MHz, the resulting mismatch will not be too serious. At higher test frequencies and/or higher reflected power levels, the load impedance will change when the wattmeter is removed from the circuit.

When the line and load impedances are known, the system's VSWR equals the ratio of the two. Always divide the larger impedance by the smaller, since VSWR must always be greater than 1.

As an example, consider using a Bird 43 to tune a 70 ohm line. If the load impedance is also 70 ohms, the wattmeter will measure a VSWR of $70/50 = 1.4$. However, if you remove the wattmeter, the VSWR will actually be 1.0. Similarly, if the load impedance is 35.7 ohms, the VSWR will be $50/35.7 = 1.4$ with the wattmeter and $70/35.7 = 2.0$ without it. Caution must therefore be used, since both good and bad matches can have the same measured VSWR. In this case, the correct impedance can be determined by slightly changing the load impedance. When the load impedance is near 70 ohms, the Bird 43 will read increasing VSWR as the load impedance is increased.

 NOTE: When working with non-50 ohm lines, it is especially important to calculate the load power by subtracting the reflected power from the forward power.

When transporting the Bird 43, insert the original dust plug, or an element with the arrow pointing upward, in the element socket and secure with the catch. This will shunt the meter circuit and protect the meter by dampening needle action during handling and shipping. Also, secure spare elements in their sockets with the pivoting knob; just insert the element and twist the knob one-quarter turn.

CAUTION

Handle elements with care. Calibration could be disturbed if they are dropped.

Connections

WARNING

Leaking RF energy is a potential health hazard. Never attempt to connect or disconnect equipment from the transmission line while RF power is being applied. Severe burns, electrical shock, or death can occur.

Insert the Bird 43 in coaxial transmission lines of 50 ohms nominal impedance. The RF source can be connected to either side of the wattmeter without affecting readings.

If non-50 ohm cables are used, a mismatch will occur causing inaccuracies in readings. However, if a mismatch cannot be avoided, refer to “Impedance Mismatch” on page 16 for instructions. It is strongly advised that this condition be avoided.

The Bird 43 is normally supplied with Quick-Change Female N type connectors. Other Bird “QC” connectors are available, refer to the Replacement Parts List in the Maintenance Chapter. Quick-Change connectors can be replaced by removing the 8-32 screw at each corner of the connector and then pulling it straight outward. Install the new connector by reversing this procedure.

Remote Installation

The RF line section can be removed from the meter housing for remote installation. To do so:

1. Unscrew the four 8-32 flat head screws securing the back cover.
2. Grasp the back cover by the side tabs behind the line connectors and pull straight back to remove it.
3. Remove the two 10-32 oval screws on the front of the housing.
4. Slide the line section out of the housing. Do not loosen the two oval screws on the sides of the housing in line with the meter. These hold the shock ring in place.
5. Replace the cable attaching the line section to the meter with one of sufficient length to complete the remote installation.
6. To replace the RF line section, reverse these steps.

In some systems it may be desirable to have two or more line sections permanently installed. In this case, one set of elements and one meter can be used to measure several separate RF transmission lines. Additional RF line sections are available.

The RF line section of the Bird 43 lends itself very readily to panel mounting. A layout for the panel cut is given in Figure 7. The thickness of the panel should be about $\frac{1}{4}$ inch. On thinner panels, build up the thickness with pads or washers to achieve a flush-face mounting. Attach the line section so that the finger catch is in the most accessible position.

Figure 7
Panel Cut for
Mounting RF
Body

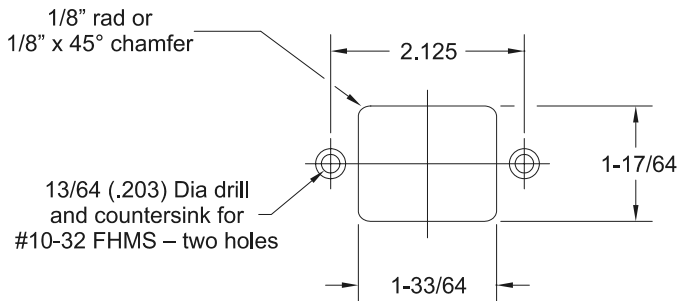

WARNING

When working with RF powers of 200 watts or more, the potential of the center conductor of the line section will exceed 100 volts. Do not touch the center conductor while RF power is on.

The Bird 43 uses plug-in elements to make measurements. The element's frequency range and maximum power are listed on its label. The transmitter test frequency should be within the band of the element used. See "Frequency Response" on page 14 for information on using the elements outside of their specified frequency range.

The arrow on the element indicates directional sensitivity; i.e., the direction of power flow that the meter will read. Rotate the element to select forward or reverse power measurement.

Combining the ThruLine Wattmeter with a Bird Termline Load Resistor creates an accurate absorption wattmeter. With this combination, readings only need to be taken in the forward direction because the reflected power will be negligible.

Normal Operation

- Insert the appropriate element in the line section socket.
- Turn the element so that the arrow points towards the load to measure forward power and towards the source for reflected power.

- Turn on the RF source.
- Read the power using the scale whose full-scale marking matches the element's maximum power.

Figure 8
Element
Direction

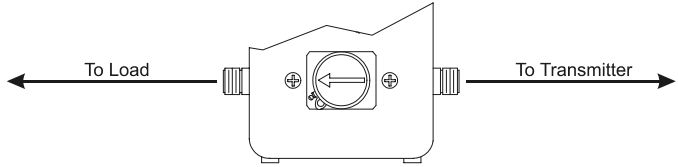

Forward Power Measurement

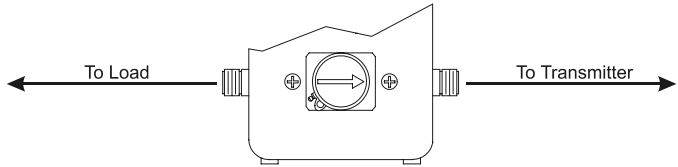

Reflected Power Measurement

When readings are being made with the wattmeter connected to an auxiliary RF line section, do not put an element in the unused line section. Otherwise, the dc circuit will be unbalanced or shorted, causing inaccurate or zero power readings.

For your convenience, a set of VSWR conversion nomographs is included in this manual. With these charts, VSWR may be determined from the forward and reflected power readings. Find the intersection of the forward and reflected power measurements. The slanted line passing closest to this point indicates the VSWR.

Figure 9
 VSWR Conversion Graph (Reflected Power 0.2 – 20.0)

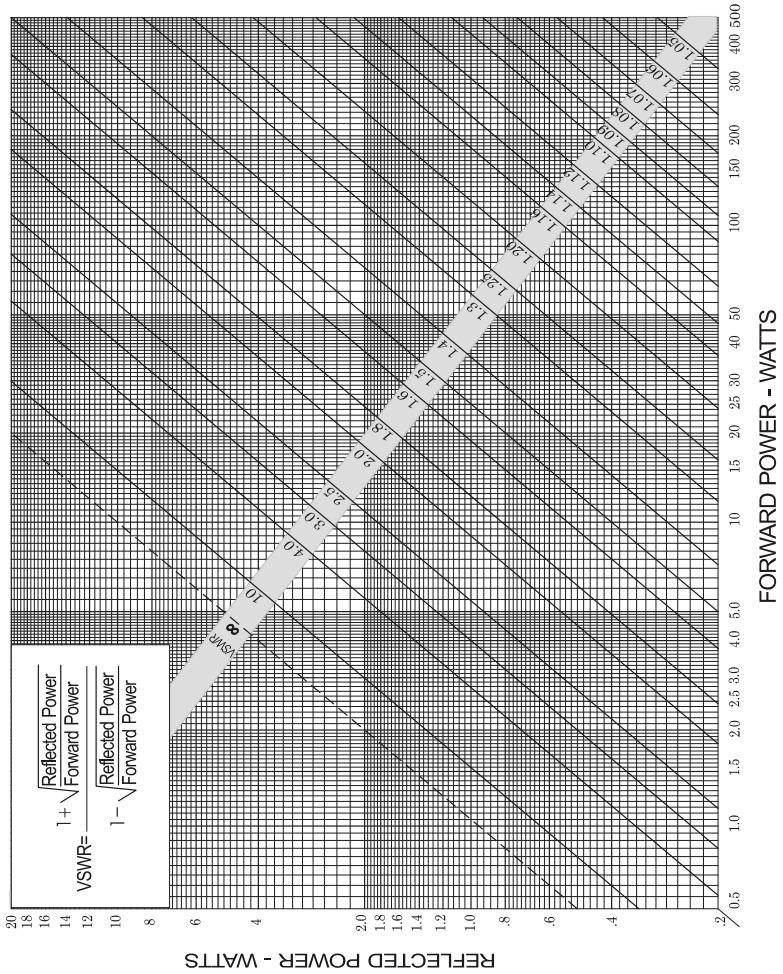
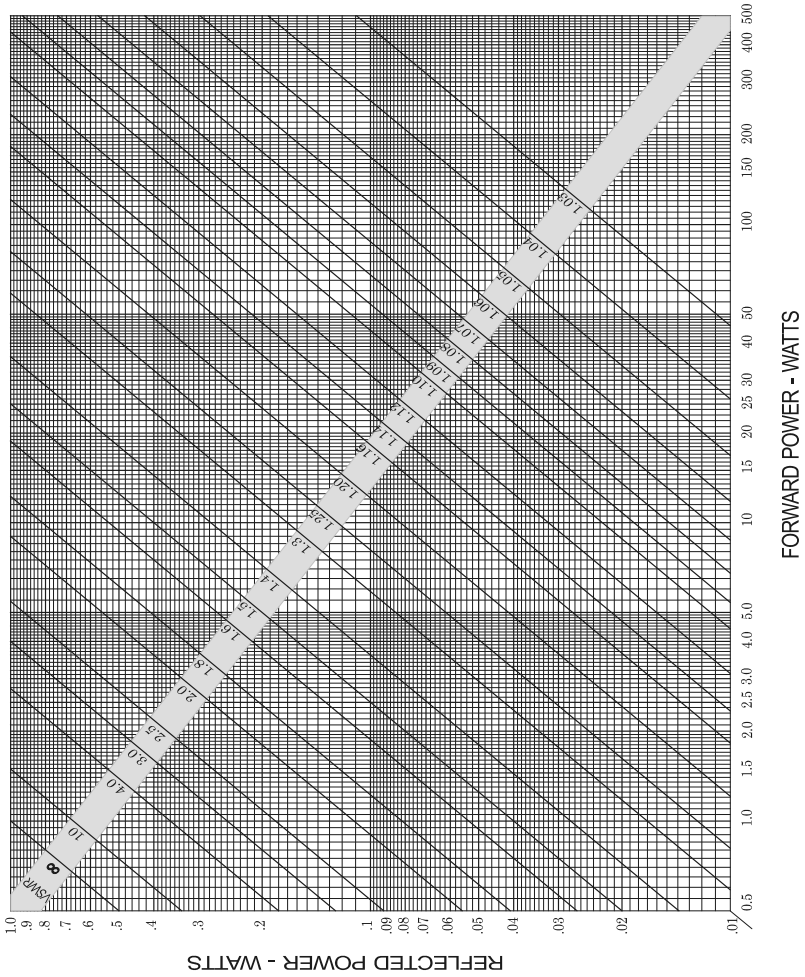

Figure 10
VSWR Conversion Graph (Reflected Power 0.01 – 1.00)



Load Matching

When a Bird 43 is used to tune a load to a transmitter and a good match is obtained, removing the unit will not change the match quality. A good 50 ohm load can terminate a 50 ohm transmission line of any length without altering conditions at the transmitter. The 43 is just an extra length of 50 ohm line in series with the measurement.

When the load is not well matched (an antenna with a VSWR of 1.5 or 2.0) the line length between the load and the transmitter will transform the load impedance as seen at the transmitter. Removing the wattmeter shortens the total line length by four inches plus two connectors. This is still not significant at low frequencies where five inches is a small fraction of a wavelength, but at higher frequencies the frequency or power output of the transmitter may be affected.

Transmission line theory shows that if the line length changes by exactly $\frac{1}{2}$ wavelength, the impedance is unchanged. To have identical match with the wattmeter in or out of the circuit, insert or remove $\frac{1}{2}$ wavelength of line (including the unit). To do this, use a length of cable which, when added to the unit, equals a $\frac{1}{2}$ wavelength at the frequency of interest. If multiple frequencies are needed, a separate cable length is required for each. See Figure 11 for sample cable lengths.

 NOTE: Cable length is measured from end to end of the connector's outer conductor, except for UHF or mini-UHF plugs where the length is measured from tip to tip of the center pins.

 NOTE: Dimensions shown are for solid polyethylene cable like RG-58C/U or RG-8/U, which have a velocity of propagation 66% of that of air. If RG-58 or RG-8 type cables containing foam polyethylene (velocity of propagation of 79%) are used, the dimensions in the graph must be multiplied by the ratio of the relative velocities; $79\% \div 66\% = 1.2$ in this case.

Figure 11
Cable Length / Wavelength Matching



The rugged and simple design of the Bird 43 means that it requires minimal routine maintenance.

Troubleshooting

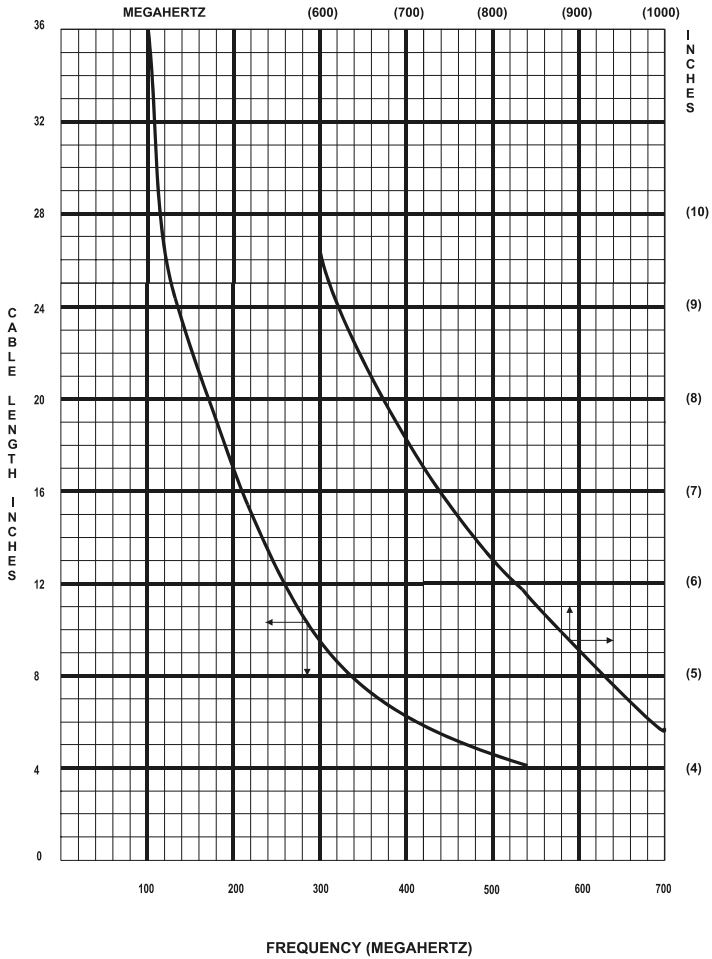
The following table contains troubleshooting information for problems that can occur during normal operation. Find the problem on the table, review possible causes, and perform the corrective action listed.

This manual does not list all malfunctions that may occur, or all corrective actions. If a malfunction is not listed or not corrected by the listed actions, contact the nearest Bird Service Center for assistance.

Problem	Possible Cause	Corrective Action
No meter reading	No RF power	Check RF source
	“Arrow” on element pointing wrong way	Rotate element
	DC contact bent	Adjust contact (page 29)
	Open or short circuit in meter	Replace defective cable (RG-58/U)
	Meter burned out or damaged	Return wattmeter for service

Intermittent or inconsistent meter reading	Dirty dc contact on element	Clean contact (page 28)
	Faulty transmission line or antenna	Inspect line
	Sticky or defective meter	Return wattmeter for service
High VSWR or reflected power	Foreign material in line section or in RF connector	Clean connectors (page 28)
	Open or shorted transmission line	Inspect line
	Bad load or poor connectors	Inspect load, antenna, and connectors

Cleaning

It is important to keep the following surfaces clean:

- Socket bore
- DC contacts on the element
- Teflon insulators

If any of the contacts or line connectors are dirty, clean them with a cotton swab dipped in commercial contact cleaner or isopropyl alcohol.

<p style="text-align: center;">CAUTION</p>

<p style="text-align: center;">Do not attempt to remove the RF center conductor. This will damage the line section.</p>

If the RF line section seems dirty, do not loosen any connections. Clean accessible components as described above and use dry, clean air to blow out the interior.

The outside of the meter housing can be cleaned with a soft cloth dampened with a mild detergent solution. Do not wipe the meter glass with a dry cloth, or a static charge could develop that would cause an erroneous meter indication.

Contact Adjustment

When cleaning the socket bore, do not disturb the spring finger of the dc contact. If necessary, the contact can be adjusted manually. The button must be out far enough to maintain good contact, but not so far as to interfere with easy entry of the element body. To remove the dc jack and spring finger:

- Unscrew both 4-40 fillister head screws holding the jack assembly against the side of the RF line section.
- Retract the assembly. Be careful not to lose the small teflon bead that straddles the base of the spring and nests in a counterbore on the side of the line section.
- Replace the assembly (make sure that the bead is properly inserted) and the two screws.

Zero Adjust

The meter's zero setting should be checked when no RF power is present. When no power is applied the pointer should rest exactly on zero. If adjustment is required, turn the adjustment screw until the pointer is set at zero (see Figure 12).

Figure 12
Zero Adjust

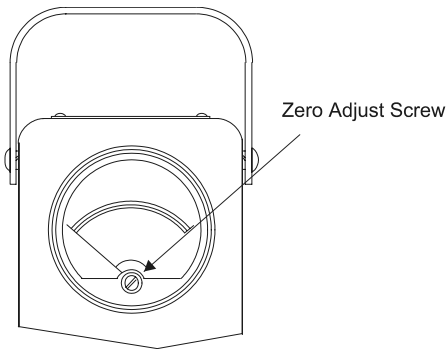

Storage

When storing the meter, keep an element or dust plug in the element socket to prevent the intrusion of dust and to prevent damage to the meter movement. When using an element, use the highest power element available. Turn it so that the "arrow" points up (midway between the FWD and RFL positions). This protects the meter and will not expose the element diode to dangerous potentials should the line section be energized.

Customer Service

If you need to return the unit for any reason, contact the Bird Service Center for a return authorization. All instruments returned must be shipped prepaid and to the attention of Bird Service Center:

Bird Service Center
30303 Aurora Road
Cleveland (Solon), Ohio 44139-2794
Phone: (440) 519-2298
Fax: (440) 519-2326

Sales Facilities

For the location of the Sales Office nearest you, give us a call or visit our Web site at:

<http://www.bird-electronic.com>

Bird 43 Replacement Parts List

Description	Qty.	Part Number
Housing Assembly	1	4210-018
Cover Assembly	1	4210-005-1
Line Section Assembly	1	4230-018
Carrying Strap	1	8580A003
Dust Plug, Aluminum	1	3610-031
DC Connector Assembly	1	4230-010
DC Connector	1	7500-076
Microammeter	1	2080-002
Coaxial Cable Assembly	1	4220-097-1
Turnbutton	2	4300-015
Spring Washer	2	5-1144-1
Rubber Stem Bumper	8	5-1388
Pushnut	2	5-1076-1
Replacement Meter Kit	1	8-000
RF Connectors	2	See list on next page

Available “QC” Type Connectors

Connector	Part Number	Connector	Part Number
BNC-Female	4240-125	Open Term. # 10-32 Nut	4240-363
BNC-Male	4240-132	SC-Female	4240-090
C-Female	4240-100	SMA-Female	4240-336
C-Male	4240-110	SMA-Male	4240-334
HN-Female	4240-268	TNC-Female	4240-156
HN-Male	4240-278	TNC-Male	4240-160
LC-Female	4240-031	UHF-Female	4240-050
LC-Male	4240-025	UHF-Male	4240-179
LT-Female	4240-018	7/16” IEC (Jack) Type 169-4	4240-344
LT-Male	4240-012	7/16” IEC (Plug) Type 169-4	4240-080
Mini UHF-Female	4240-346	7/8” EIA	4240-002
N-Female	4240-062	1-5/8” EIA Fixed	4240-096
N-Male	4240-063	1-5/8” EIA Swivel	4240-208

Bird 43P Peak Wattmeter

The Bird 43P Thruline Wattmeter is the same as the Bird 43, with the added capability of measuring peak power in AM, SSB, and some pulse applications. A conversion kit (P/N 4300-400) is available to give peak reading capability to any standard Bird 43. This kit comes with all necessary parts and easy to follow instructions for simple and quick conversion.

Special elements are not required. However, the element power rating must match the peak power to be measured. For example, if 1000 watt peaks are expected, use a 1000 watt element.

Operation

There is a push button on/off switch on the right side of the meter.

- To read peak power, push the switch in. The red LED will light.
- To read CW power, push the switch again. The LED will turn off.

Peak Detector Response

Since the peak detector's response time is about one second, a short delay may be noticed before the meter reading stabilizes. This will also be noticed when the transmitter is turned off. In voice modulated systems, the meter reading may fluctuate by 2–3 minor scale divisions as the peak detector attempts to follow the power variations.

Rectangular Pulses

When measuring rectangular pulse power, note the following signal requirements:

- Duty Cycle: 2%, minimum
- Rep. Rate: 100 pps, minimum
- Pulse Width: 200 μ s, minimum

Peak Calibration

If recalibration is required, refer to figure 15 and these instructions:

1. Unscrew the four 8-32 flat head screws securing the back cover.
2. Grasp the back cover by the side tabs behind the line connectors and pull straight back to remove it.
3. Insert the Bird 43P between a reliable CW signal source and a 50 ohm load.
4. Insert an element with the appropriate power and frequency range into the Bird 43P. Turn it to read forward power.
5. Set the wattmeter to CW mode (LED off).
6. Turn on the signal source and adjust the source power to give a stable reading in the upper half of the wattmeter's scale.
7. Switch the wattmeter to PEAK mode (LED on).
8. Adjust the potentiometer (R9) until the PEAK reading is the same as the CW reading.
9. Replace the back cover.

Maintenance

Maintenance of the Bird 43P is the same as for the Bird 43 except for battery replacement. Battery life should typically be 48 hours.

If the unit does not function properly in peak mode or if calibration cannot be achieved, the batteries may be low. Replace with two new 9 V alkaline or lithium batteries. The batteries fit very tightly in their retaining clips and may have to be pried out one at a time.

Figure 13
Model 43P

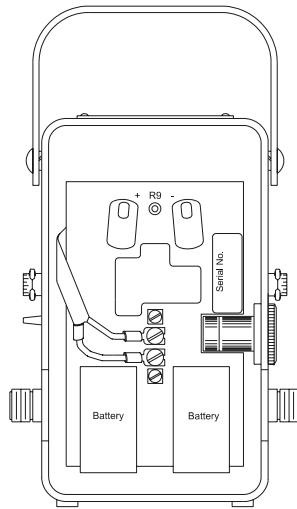

Bird 4305A Thruline Wattmeter

The Bird 4305A Thruline Wattmeter is the same as the Bird 43 except for the following physical differences:

- The Bird 4305A's dimensions are 4-5/16" L x 4" W x 6-7/8" H (110 x 102 x 175 mm), including element and bumper feet. The weight is 3.25 lb. (1.5 kg), including the element.
- The Bird 4305A does not have holders for spare elements.
- The Bird 4305A line section has higher operating power capability and is 1-5/8" in diameter, instead of 15/16" as in the Bird 43.

Theory, maintenance, and all instructions for the Bird 43 also apply to the Bird 4305A.

Bird 4305A Replacement Parts List

Only parts which are not used on the Bird 43 are listed here.

Description	Qty.	Part Number
Housing Assembly	1	4305A003
Cover Assembly	1	4305A002
Line Section Assembly	1	4305-005

Bird 4431 Thruline Wattmeter

The Bird 4431 RF Sampling Wattmeter is the same as the Bird 43 Thruline Wattmeter except for a RF signal sampler probe.

The RF sampler provides a low power sample of the signal being transmitted through the wattmeter's linesection. This signal is available at the female BNC connector labeled "RF SAMPLE", on the right side of the housing. The signal level can be set with the control knob on the front of the meter. The table below lists approximate attenuation levels, and notes maximum suggested adjustment. The sampler output may be fed to any suitable RF signal monitoring device; e.g. a frequency counter, spectrum analyzer, or oscilloscope. All other operation instructions are the same as for the Bird 43.

Sampler at max (Fully clockwise)	
Freq. (MHz)	Atten. (dB)
2	69
10	57
25	46
50	42
75	39
100	36
200	31

Turned counter- clockwise 4 full turns from max*	
Freq. (MHz)	Atten. (dB)
300	38
400	34
500	30
600	29.5
700	29
800	28.5
900	28

Turned counter- clockwise 7 full turns from max*	
Freq. (MHz)	Atten. (dB)
800	36
900	35.5
1000	35

* Approximate attenuation

Maintenance

Do not make repairs to the probe assembly. If the sampler malfunctions, we recommend returning the unit to the Bird Service Center for repair. To replace the probe assembly, follow these instructions:

1. To reach the probe, unscrew the four 8-32 flat head screws securing the back cover.
2. Grasp the back cover by the side tabs behind the line connectors and pull straight backward to remove it.
3. Use a 1/16 hex socket wrench to remove the small coupling control knob on the front of the wattmeter.
4. Remove the two 8-32 x 1/4" screws fastening the guide and plate assembly to the back of the line section.
5. Put the control knob back on the shaft, then turn it counterclockwise until the collar is free of the shaft. Remove the control knob.
6. Pull the probe plate straight out of the pin and guide bushing.
7. Unscrew the 5/8 hex nut on the BNC connector and pull the sampler connector into the case. The probe plate assembly, P/N 4431-003, is now released and may be replaced.
8. The sampler cable (RG-58/U) center conductor is soldered to the probe's rear stub. The cable is secured to the side sleeve of the probe with the same screw used in the dc connector plug assembly, P/N 7500-076. It may be removed by unscrewing the 3/8 hex screw, unsoldering the lead tip and pulling out the cable. The probe assembly is formed into the socket and is not replaceable.
9. Replace by carefully reversing the above procedures.

 NOTE: When inserting the control bushing, be sure the alignment pin is properly positioned.

Bird 4431 Replacement Parts List

Only parts which are not used on the Bird 43 are listed here.

Description	Qty.	Part Number
Modified Housing (instead of 4210-018)	1	4431-011
Guide Plate Assembly	1	4431-002
Movable Plate Assembly	1	4431-003
Line section Assembly (instead of 4230-018)	1	4431-004
RF cable sampler assembly consisting of: 1 BNC (F) Connector 1 RF Cable (RG58/U) 1 BNC Connector Eyelet 1 Washer* 1 Wedge* 1 Seal* 1 Screw*		5-953 5-773-1 5-414-1 7500-074 7500-080 7500-081 7500-082
Sampler Control Knob	1	5-1193
DC Meter Cable (instead of 097-1)	1	4220-097-8

* Connector parts for probe sleeve

Bird 4520 Series Thruline Wattmeters

The Bird 4520 RF Thruline Wattmeters (models 4521, 4522, 4523, 4525, 4526, 4527) are the same as the Bird 43, except that they are panel mounted for rack installation. In addition, the Bird 4527 has a RF sampler. These units are intended for fixed installation, generally in rack mounts requiring 19" panels.

Installation

- Choose a location allowing easy reading and operation of the unit and where the cables used will be short and without sharp bends.
- Avoid the use of angles and adapters.
- Make sure all connectors are tightened securely.
- Use four 12-24 screws to fasten the wattmeter panel to the rack.

Operation

The RF sampler on the Bird 4527 provides a low power sample of main RF signal. This signal is available at the female BNC connector labeled "RF SAMPLE". The sampler output may be fed to any RF signal suitable monitoring device; e.g. a frequency counter, spectrum analyzer, or oscilloscope.

Bird 4520 Series Replacement Parts List

The mounting panel entry lists the panel styles for each model. Only parts which are not used on the Bird 43 are listed here.

Description	Qty.	Part Number
Mounting Panel (Components: M = meter, E = element socket, S = switch)	1	
4521 (1M, 1E)		4521-002
4522 (1M, 2E, 1S)		4522-006
4523 (1M, 1E)		4523-002
4525 (1M, 1E)		4525-002
4526 (2M, 2E)		4526-004
4527 (2M, 2E)		4527-005
Line Section Assembly	1	
4521/23/25		4230-018
4522/26		4522-002
4527		4527-002
DC Connector Assembly		4230-010
4521/23/25	1	
4522/26/27	2	
Microammeter		
4521/22/27	1	2080-002
4523	1	2150-015
4525	1	2080-005
4526	2	2080-002
Switch Control Knob (4522 only)	1	5-634
Rotary Switch (4522 only)	1	5-634
Cable Assembly		
4521/25 (16" L)	1	4220-097-5
4522 (Harness)	1	4522-013
4523 (16.5"L)	1	4523-003-1
4526/27 (16" L)	2	4220-097-5
RF Cable Assembly (4527 only)	1	4430-002

These specifications include data covering the Bird 43, 43P, 4305A, 4431, 4521, 4522, 4523, 4525, 4526, and 4527. Specifications for models not listed are identical to the Bird 43.

Impedance, Nominal 50 ohm

VSWR, Max.

All models except 4431 1.05:1

4431 1.07:1 (when coupling is less than 30 dB)

Connectors

Primary Line Bird “QC” (N Female normally supplied)

RF Sampling (on applicable models) Female BNC

Power and Frequency Range (element dependent)

43,43P,4521/22/23/25/26 100 mW – 10 kW
0.45 – 2700 MHz

4305 25 kW max, 0.45 – 2.5 MHz
10 kW max, 2 – 30 MHz

4431*	5000 W max, 2 – 30 MHz 1000 W max, 30 – 1000 MHz
4527	1000 W max, 2 – 200 MHz 500 W max, 200 – 512 MHz

RF Coupling

4527 (approximate)	-53 dB, 512 – 10 MHz -70 dB, 10 – 2 MHz
4431 (adjustable)	15 – 70 dB

Insertion Loss (4431 only)*

2 – 512 MHz	0.1 dB max
512 – 1000 MHz	0.1 dB max

Accuracy

CW (all models)	± 5% of full scale
Peak Power (43P only)	± 8% of full scale

Power Requirement (43P only)

Two 9V alkaline batteries
(NEDA 1604)

Battery Life (43P only)

48 hours typical

Dimensions, Nominal

43, 43P	3-5/8”L x 4”W x 6-7/8”H (92 x 102 x 175 mm)
4305A	4-1/4”L x 3-7/8”W x 6-7/8”H (108 x 99 x 175 mm)

4431 3-7/8”L x 4”W x 6-7/8”H
(99 x 102 x 175 mm)

4521/22/23/25/26/27 19”W x 5-1/4”H x 1-3/4”D
(483 x 134 x 45 mm)

Weight, Nominal

43, 4521/22/23/25/26/27 3 lb. (1.36 kg)

43P 4 lb. (1.8 kg)

4431 3.5 lb. (1.59 kg)

4305A 3.25 lb. (1.47 kg)

Operating Position Any

Finish Grey Powder Coat

* Applicable only for maximum coupling less than 30 dB. This requires a minimum decoupling of four full turns counterclockwise above 200 MHz, and seven full turns above 800 MHz

Limited Warranty

All products manufactured by Seller are warranted to be free from defects in material and workmanship for a period of one (1) year, unless otherwise specified, from date of shipment and to conform to applicable specifications, drawings, blueprints and/or samples. Seller's sole obligation under these warranties shall be to issue credit, repair or replace any item or part thereof which is proved to be other than as warranted; no allowance shall be made for any labor charges of Buyer for replacement of parts, adjustment or repairs, or any other work, unless such charges are authorized in advance by Seller.

If Seller's products are claimed to be defective in material or workmanship or not to conform to specifications, drawings, blueprints and/or samples, Seller shall, upon prompt notice thereof, either examine the products where they are located or issue shipping instructions for return to Seller (transportation charges prepaid by Buyer). In the event any of our products are proved to be other than as warranted, transportation costs (cheapest way) to and from Seller's plant, will be borne by Seller and reimbursement or credit will be made for amounts so expended by Buyer. Every such claim for breach of these warranties shall be deemed to be waived by Buyer unless made in writing within ten (10) days from the date of discovery of the defect.

The above warranties shall not extend to any products or parts thereof which have been subjected to any misuse or neglect, damaged by accident, rendered defective by reason of improper installation or by the performance of repairs or alterations outside of our plant, and shall not apply to any goods or parts thereof furnished by Buyer or acquired from others at Buyer's request and/or to Buyer's specifications. Routine (regularly required) calibration is not covered under this limited warranty. In addition, Seller's warranties do not extend to the failure of tubes, transistors, fuses and batteries, or to other equipment and parts manufactured by others except to the extent of the original manufacturer's warranty to Seller.

The obligations under the foregoing warranties are limited to the precise terms thereof. These warranties provide exclusive remedies, expressly in lieu of all other remedies including claims for special or consequential damages. SELLER NEITHER MAKES NOR ASSUMES ANY OTHER WARRANTY WHATSOEVER, WHETHER EXPRESS, STATUTORY, OR IMPLIED, INCLUDING WARRANTIES OF MERCHANTABILITY AND FITNESS, AND NO PERSON IS AUTHORIZED TO ASSUME FOR SELLER ANY OBLIGATION OR LIABILITY NOT STRICTLY IN ACCORDANCE WITH THE FOREGOING.

DECLARATION OF CONFORMITY

Manufacturer: Bird Electronic Corporation
30303 Aurora Road
Cleveland, Ohio 44139-2794

Product: Thruline Wattmeter

Models: 43 4305A 43P 4330 4431

The undersigned hereby declares, on behalf of Bird Electronic Corporation of Cleveland, Ohio, that the above-referenced product, to which this declaration relates, is in conformity with the provisions of the following standards;

- EN 55011:1991 - Emissions (Class B)
- IEC 801-2:1984, Part 3 - EMF Immunity
- IEC 801-4:1988, Part 4 - Fast Transient/Burst Immunity

These standards are in accordance with EMC Directive (89/336/EEC).

- European Standard EN 61010-1:1993 - Part 1: General Requirements

This standard is in accordance with Low Voltage Directive (73/23/EEC), 1973.

The technical documentation file required by this directive is maintained at the corporate headquarters of Bird Electronic Corporation, 30303 Aurora Road, Cleveland, Ohio 44139.



Bob Gardiner
Director of Quality
Bird Electronic Corporation